



LEAF

UNIQUE SHADE SOLUTION

LEAF by HEATSAIL

*No better background scenery for a nice long
conversation than a sultry summer night.*

*Why don't we just make it a
little warmer and lighter outside,
so those summer nights can last forever...*

Or maybe we can make it cooler?







LEAF by HEATSAIL

LEAF

The outdoor room has a tranquility unlike any other. A comfortable, inviting space with fresh air and a scenic view. The essential element of the outdoor room, however, is shade. The number one reason people choose to avoid their outdoor room is lack of shelter from heat and rain.

Providing needed shade is what our LEAF does best – supplying protection from the elements, it heats, cools and enlightens with undeniable style. The elegant LEAF-shaped design of this future-proof solution allows it to blend harmoniously into its surroundings.



LEAF by HEATSAIL

HEATSAIL

Heatsail is a Belgian design company established in 2012 that has redefined the luxury lighting, heating and cooling space. We develop unique technical outdoor products to create longlasting experiences by extending the finest moments of a beautiful day.



10



LEAF by HEATSAIL

UNIQUE

The LEAF opens and closes with a touch of your finger, while your guests can stay underneath.

Worldwide patented.

Forgot to close it ? No problem, when there is too much wind it senses the vibration and closes for you.

When open, you get a massive 4.6 by 3.6 meter surface.
...And of course you can rotate it by 360°.



LEAF by HEATSAIL

A close-up, low-angle shot of a modern ceiling light fixture. The fixture is a long, narrow, metallic strip with a brushed metal finish. On the right side, a square panel is illuminated with a warm, yellowish-orange light. To the left of this panel is a dark, recessed area with a series of parallel slats, likely a vent or a decorative element. The background is a dark, textured ceiling with a small, dark, circular object (possibly a screw or a sensor) visible. The overall lighting is dim, emphasizing the glow from the fixture.

LIGHT

When it gets darker you turn on the light. 6 lightpoints distributed over the length of the LEAF give you plenty of light. After dinner? The integrated touch panel lets you dim the lights.

HEATSAIL



LEAF by HEATSAIL

HEAT

When it gets chilly just turn on the integrated heating. Discrete far-infrared heating elements give you the most pleasant warmth. They are also evenly distributed over the length of the LEAF, so everybody enjoys it. And of course you have different levels of heat.



LEAF by HEATSAIL

COOL

When it gets really too hot switch on the misting. Integrated channels on both sides of the LEAF create a fine mist. A combination of very small orifices and high pressure lets water evaporate in the air before it makes your hair frizz. It cools the surrounding air up to 15°C. Want to have control on how and when? Use the smartphone app and you are the cooling master.

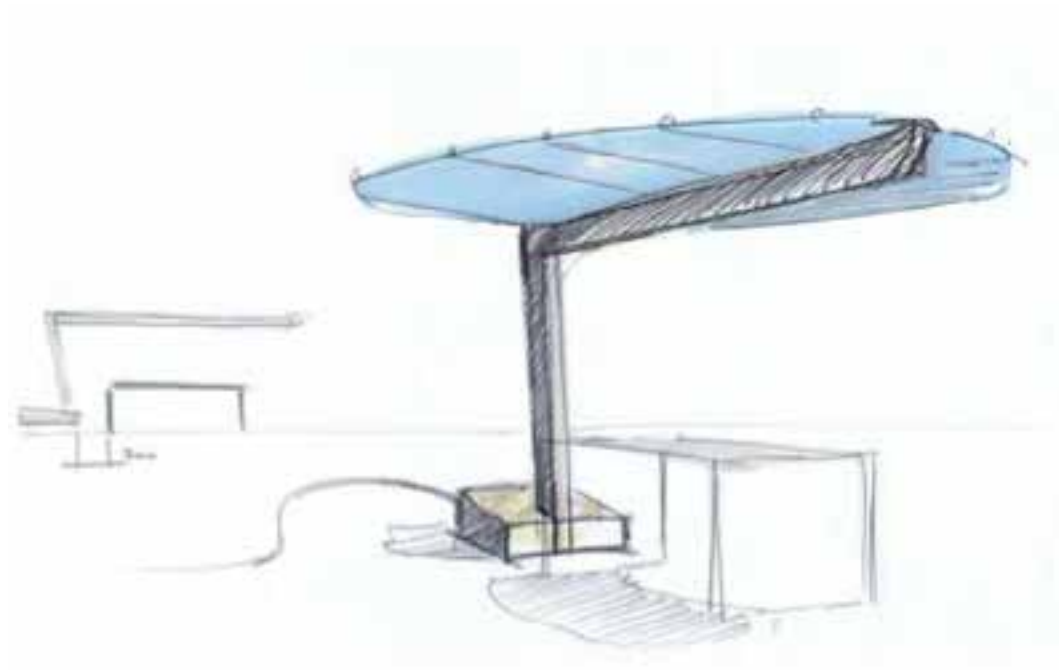

18

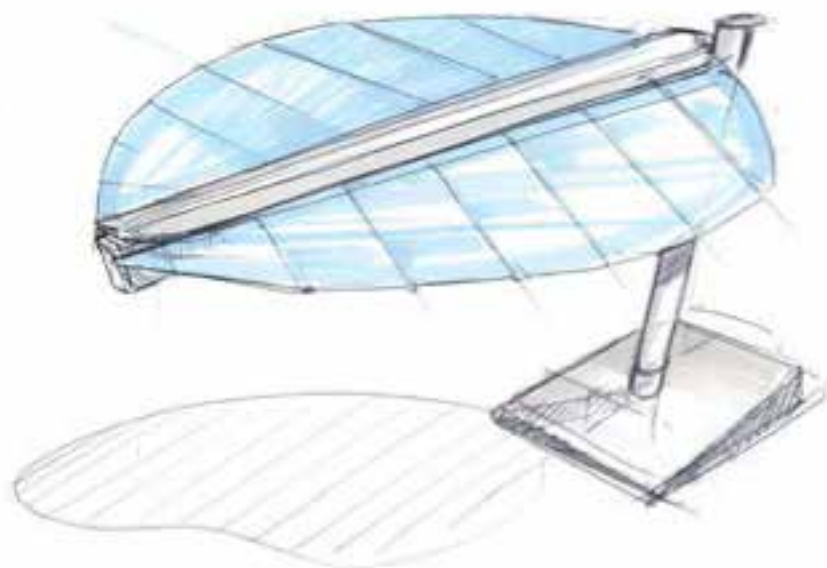

LEAF by HEATSAIL

CONCEPT

The LEAF should be a daily life companion, functional, easy to use and a beautiful object that can harmoniously fit with other outdoor products. Heatsail defined the shapes of the three main components; the base, the structure and the fabric. Combining these aesthetic choices with the technical elements for optimal cooling, heating and lighting has resulted in a durable and functional design object.

Technical information

Base

Square 900x900x140mm - 400 KGS
360° Rotation with fixation pin



Open / Close

Electric Motor with safety features:

- Closes automatically when there is too much vibration
- Closes automatically when tilted
- Manual release pin when power out

Cooling / Misting

10 Misting nozzles with .10mm orifice
High pressure pump 180W - 70bar -57dB
Delivered with 25m tube dia 8mm
Pump to be connected to water faucet

Controlled by smartphone app:

On/Off - Running time - Intermittent - Clock



Dimensions

Length	460 cm
Width	360 cm
Height	225 cm

Technical specifications

Heat	3000 Watt
Light	94 Watt
Misting	150 Watt

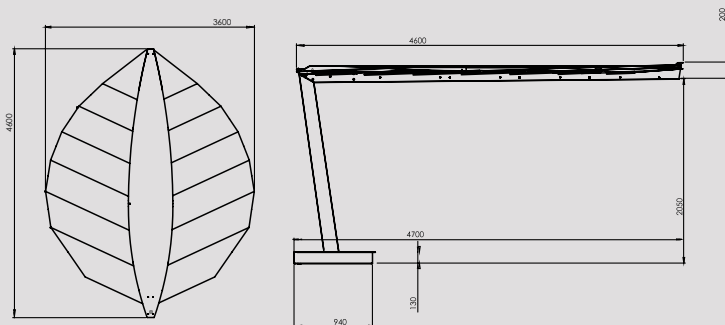

Touch panel functions

- Open / Close
- Lights On/Off - Dim
- Heating 50%
- Heating 100%
- Misting

Frame Colours

Colours are indicative.

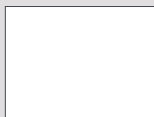

Snow

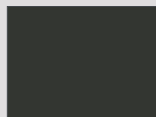

Mud

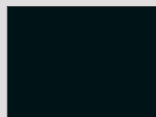

Midnight

Fabric colours

Colours are indicative.

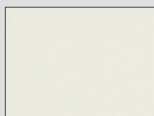

Off-white



Canvas



Flannel

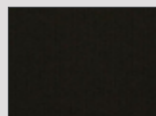

Black

Extend your great moments

CONTACT

Headquarters

Heatsail NV
Prins Boudewijnlaan 7, A08
2250 Kontich (Antwerp)
Belgium

+32 (0)3 502 99 88
sales@heatsail.com

 HEATSAIL.COM

 HEATSAIL

 HEATSAILBELGIUM

 HEATSAIL

 HEATSAIL

23

Heatsail USA Inc.

10440 N Central Expressway, Suite 800
75231 Dallas, Texas
United States of America

+1 214 808 5091
sales@heatsail.com



LEAF by HEATSAIL